

Japanese Macaque

Theme: Crease pattern fold
Fold using 6" (15 cm) origami paper.

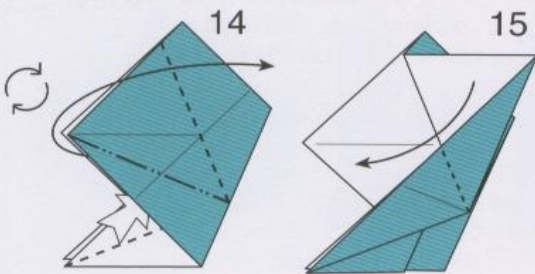

Repeat steps 14-15.

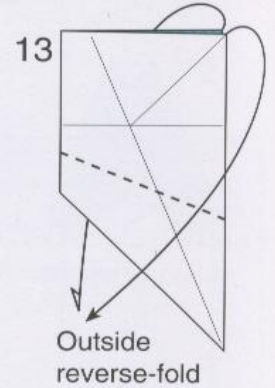
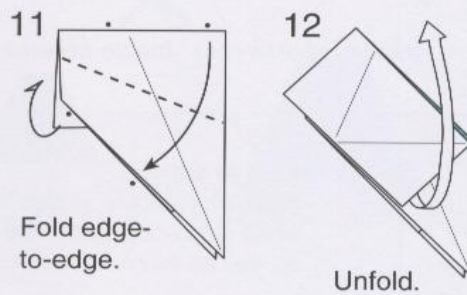
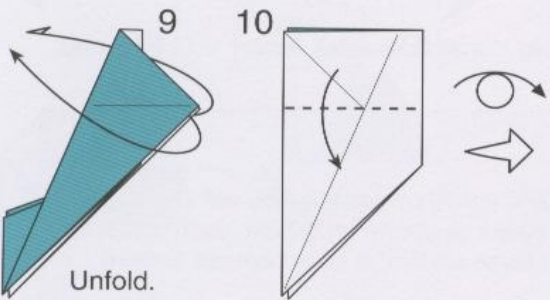
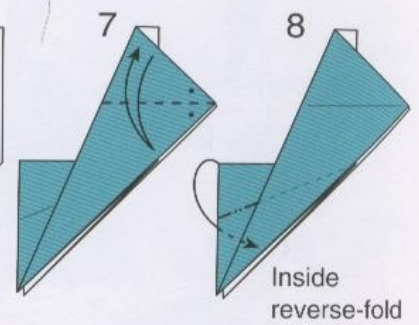
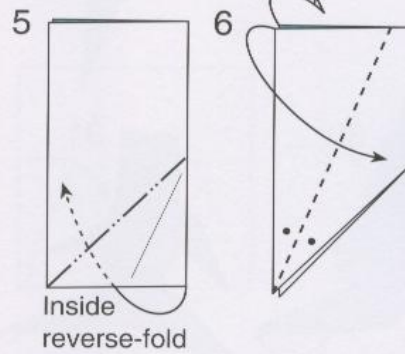
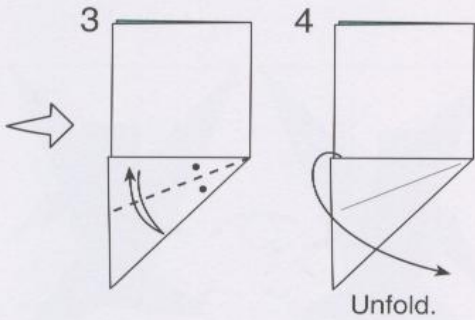
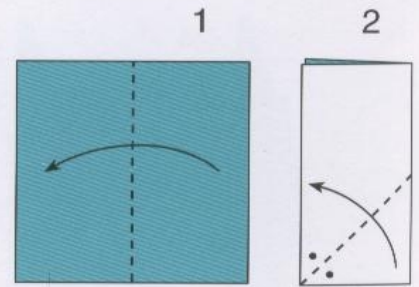
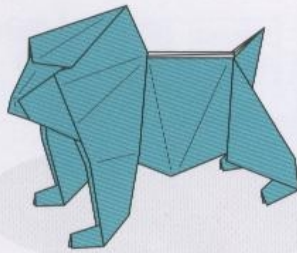
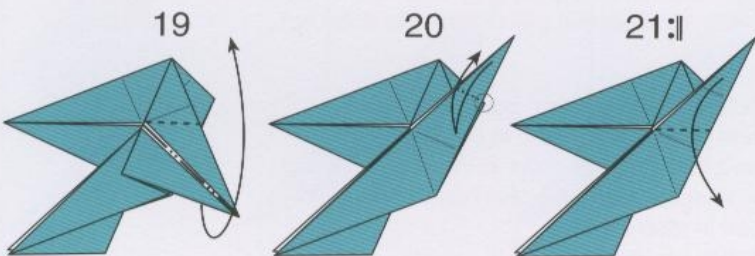
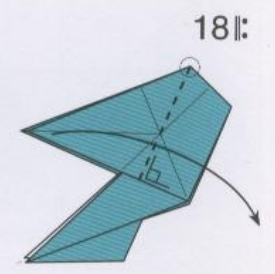
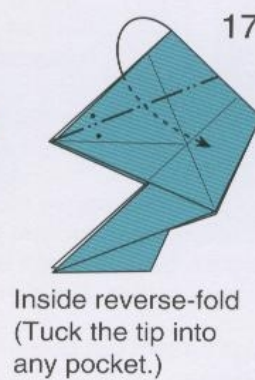
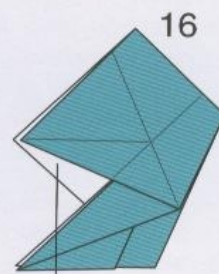

Repeat steps 18-21.

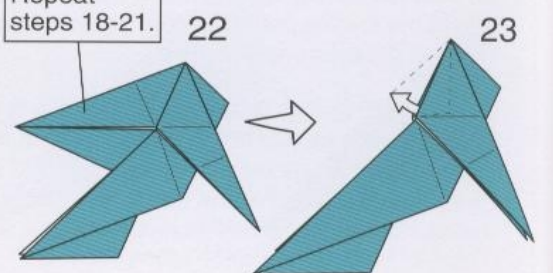

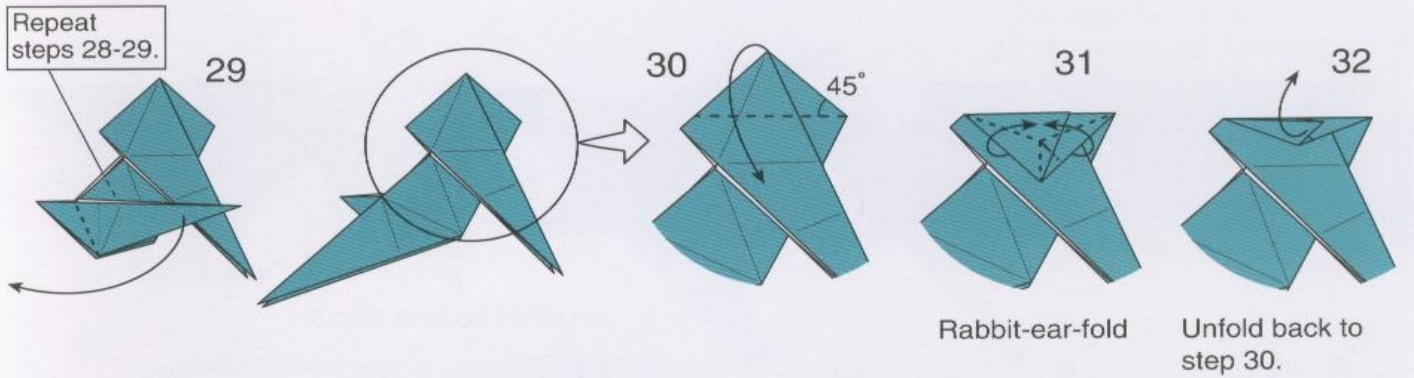
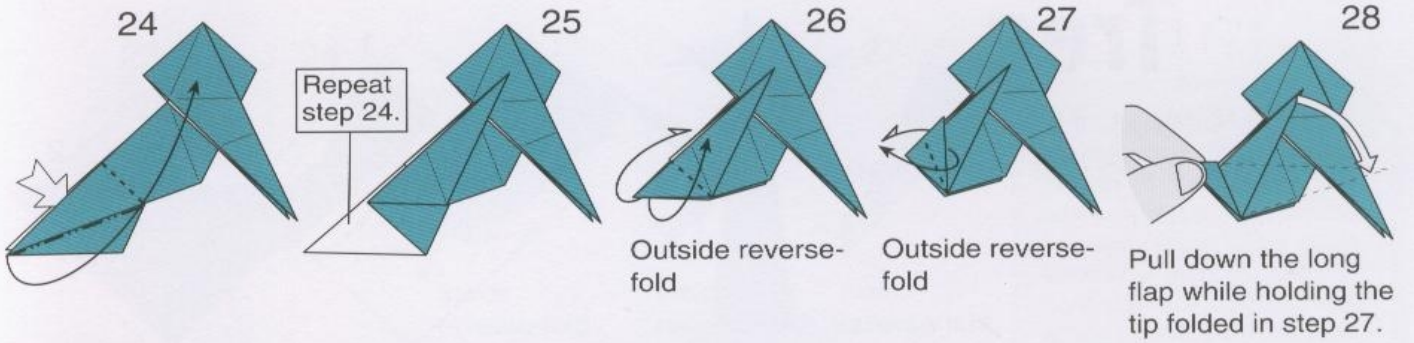

Steps 33-34 show a kind of sink fold, which I would call **crease pattern fold**. To fold it, you must understand the crease pattern in the circle.

